

Folding Fittings

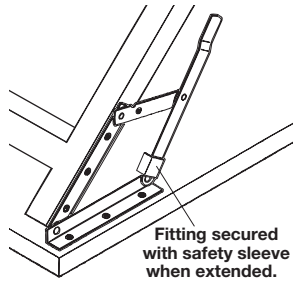

Folding Bracket

- For tables and benches
- Height is not lost if the fitting is mounted on the side of the table leg
- L-steel support: 25 x 25 x 3 mm (1" x 1" x 1/8")
- Supporting arm length: 200 mm (7 7/8")

Material: Steel, lacquered

Color	Item No.
black	642.81.300

Set Supplied With
2 brackets

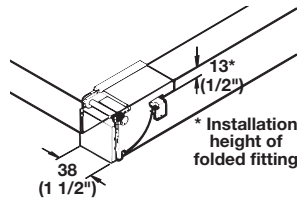
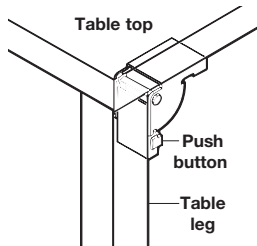

Folding Fitting

- For tables and benches
- For 38 x 38 mm legs
- Locks in position, open and closed

Material: Steel, galvanized

Item No.
642.90.919

Set Supplied With
2 fittings

6

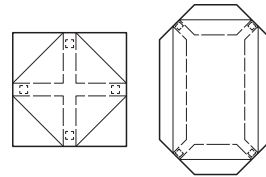
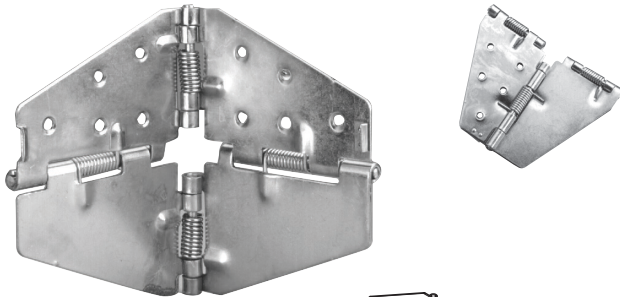

Note

Table leaves are held securely under table. Rotate leaves up (180°) and hinges automatically lock leaves into horizontal position. Flap hinge is designed for relatively light duty applications. Flap should not exceed 8" in depth, please conduct your own test. **Häfele cannot specify a weight rating.**

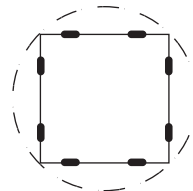

Converts square tops to round tops, or other shapes

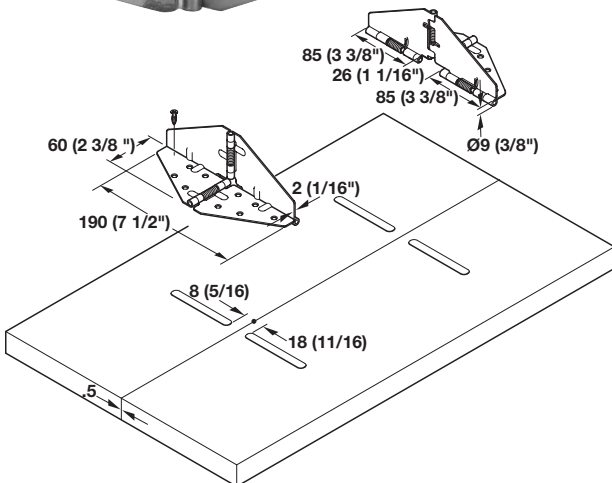

Table Leaf Flap Hinge

Material: Steel

Finish	Item No.
yellow chromate	642.70.515

Note

Hinge is under constant spring tension. Keep fingers clear when operating.

Flat head screws

Pages 11.137-11.138, 11.140

Dimensions in mm
Inches are approximate