









Brackets

For Upper Guide Channel	Description	Material	Finish	Item No.
	Bracket for soffit mounting	Steel	galvanized	942.53.080
	Closed end piece to bracket	Steel	galvanized	941.80.082
	Bracket for soffit mounting, lock joint type	Steel	galvanized	942.53.082

For Upper Guide Channel	Description	Material	Finish	Item No.
	Double sidewall bracket for parallel wall mounting, open-end type	Steel	galvanized	941.80.080
	Closed end piece to bracket	Steel	galvanized	941.80.082
	Double sidewall bracket for parallel wall mounting, lock joint type	Steel	galvanized	941.80.801

For Single Upper Guide Channel	Description	Material	Finish	Item No.
	Sidewall bracket for wall mounting, open-end type	Steel	galvanized	941.80.060
	Closed end piece to bracket	Steel	galvanized	941.80.082
	Lock joint plate	Steel	galvanized	942.52.082

Position of mounting brackets along the upper guide channel

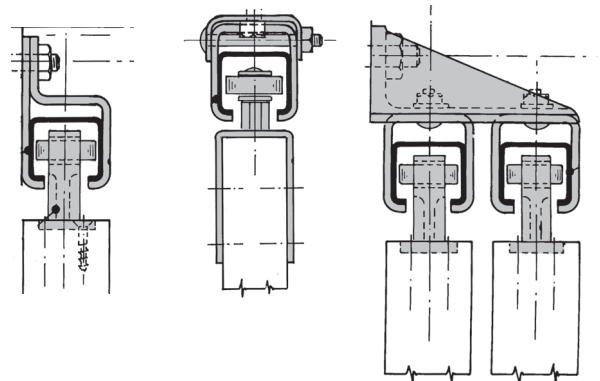
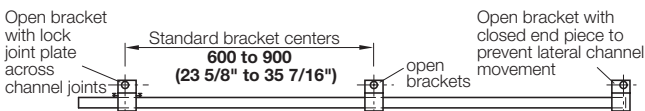

Dimensional data not binding. We reserve the right to alter specifications without notice.

Dimensions in mm
Inches are approximate