









Set

| | |
|--|------------|
| | Item No. |
| | 941.00.007 |





Set Components

| | Description | Material | Color/Finish | Qty. | Item No. |
|---|---|----------|--------------|--------|------------|
|  | Double roller running gear | - | - | 2 pcs. | 941.00.015 |
|  | Suspension bolt, M8 x 32 | Steel | zinc-plated | 2 pcs. | 940.54.021 |
|  | Set nut, M8 | Steel | zinc-plated | 2 pcs. | 940.54.022 |
|  | Clamp shoe adjustable from 6 - 12.7 (1/4" - 1/2") | Aluminum | mill finish | 2 pcs. | 941.00.020 |
|  | Track stopper, with adjustable retention spring | Plastic | gray | 1 pc. | 940.60.043 |
|  | Track stopper | Plastic | gray | 1 pc. | 940.60.041 |
|  | Floor guide, adjustable from 6 - 12.7 (1/4" - 1/2") | - | - | 1 pc. | 941.00.031 |
|  | Buffer | Rubber | black | 1 pc. | 940.60.051 |

Note

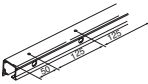
Item numbers are valid for only 1 piece, when ordering individual components please state the desired amount. For 2 bi-parting sliding glass doors please order 2 sets.

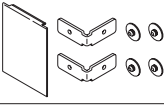
Individual Components

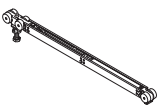
| | Description | Material | Color/Finish | Length | Item No. |
|---|--|----------|--------------|--------------------|------------|
|  | Upper Tracks, pre-drilled, 41 x 39 (1 39/64" x 1 17/32") | Aluminum | unanodized | 2.5 m (8' 2 7/16") | 941.00.253 |
| | Upper Tracks, pre-drilled, 41 x 39 (1 39/64" x 1 17/32") | | | 6 m (19' 8 1/4") | 941.00.603 |
|  | Clip-on Fascia to upper track, 94.5 x 9 (3 23/32" x 23/64") | Aluminum | anodized | 2.5 m (8' 2 7/16") | 941.00.825 |
| | Clip-on Fascia to upper track, 94.5 x 9 (3 23/32" x 23/64") | | | 6 m (19' 8 1/4") | 941.00.860 |
|  | End piece to fascia, one-sided, wall mounted | Aluminum | anodized | 44.5 mm (1 3/4") | 941.00.066 |
| | End piece to fascia, one-sided, ceiling mounted | | | 49 mm (1 59/64") | 941.00.070 |
|  | Clip piece for wood fascia, 97 x 29 x 9.5 (13/16" x 1 1/8" x 3/8") | Aluminum | unanodized | - | 941.40.065 |
|  | Seal | Plastic | black | 20 m (65' 7 7/16") | 941.00.094 |
|  | Soft closer 10 - 60 kg (22 - 132 lbs.) | | | | 940.60.045 |
| | Soft closer 61 - 100 kg (135 - 220 lbs.) | | | | 940.60.010 |
| | Cover cap for soft closer | | | | 940.60.094 |
| | Drill jig for soft closer | | | | 940.60.095 |

Note

Mounting instructions (included in fitting set) for planning and execution available upon request.

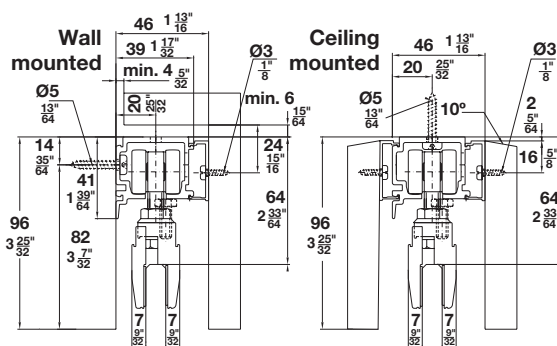

Mounting options with wood fascias

Fixing distance for clip component every 400 to 600 mm (15 3/4" - 23 5/8")

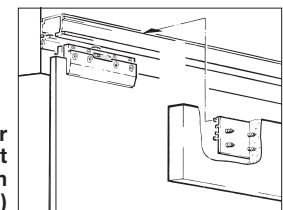

Floor mounted door stop

Page 1.204

HAWA Toplock

Pages 1.289-1.293

Dimensions in mm
Inches are approximate