















# Top Hung System

## Accessories

	Description	Material/Finish	Finish	Length	Item No.
	Wall attachment	Stainless steel	matt	5 (3/16")	941.07.102
	Attachment, special tool	Stainless steel	matt	-	941.07.117
	Door stopper for Unotec Home	Stainless steel	matt	58 (2 1/4")	941.07.126
	Door stopper for Flatec, Tritec	Stainless steel	matt	45 (1 3/4")	941.07.127
	Bottom guide, for wood doors D ≤ 45.1 (1 3/4")	Stainless steel	-	-	941.07.131
	Hanger bolt	Stainless steel	-	5/16" - 18, 4" long	026.13.014
	Hanger bolt	Stainless steel	-	5/16" - 18, 4" long	026.13.015
	Hanger bolt	Stainless steel	-	5/16" - 18, 5" long	026.13.016
	Hanger bolt	Stainless steel	-	5/16" - 18, 5" long	026.13.017
	Hanger bolt	Stainless steel	-	5/16" - 18, 6" long	026.13.018
	Hanger bolt	Stainless steel	-	5/16" - 18, 6" long	026.13.019
	Compensation disk set, 2 (1/16") thick	Stainless steel	matt	-	941.07.105
	Compensation disk set, 5 (3/16") thick	Stainless steel	matt	-	941.07.106
	Compensation disk set, 10 (3/8") thick	Stainless steel	matt	-	941.07.107

Dimensional data not binding. We reserve the right to alter specifications without notice.

Standard installation

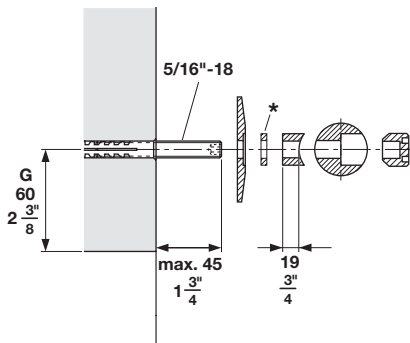

Installation with baseboards and trim

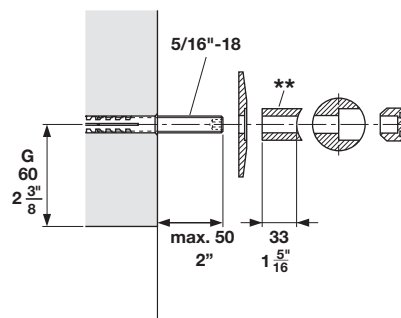

\* If needed the distance between the wall and the track can be adjusted by adding one of the compensation discs per wall attachment.

\*\* For installations with a baseboard or door trim please order the baseboard spacer separately; one per wall attachment.

Dimensions in mm  
Inches are approximate